

SCHLETTER

PROLINE

UNLIMITED POSSIBILITIES.

- + FIXGRID PRO
- + UNIVERSAL FASTENERS
- + SEAM CLAMPS
- + MODULE CLAMPS
- + MODULE BEARING RAILS
- + TRAPEZOIDAL SHEET CONNECTION
- + ACCESSORIES

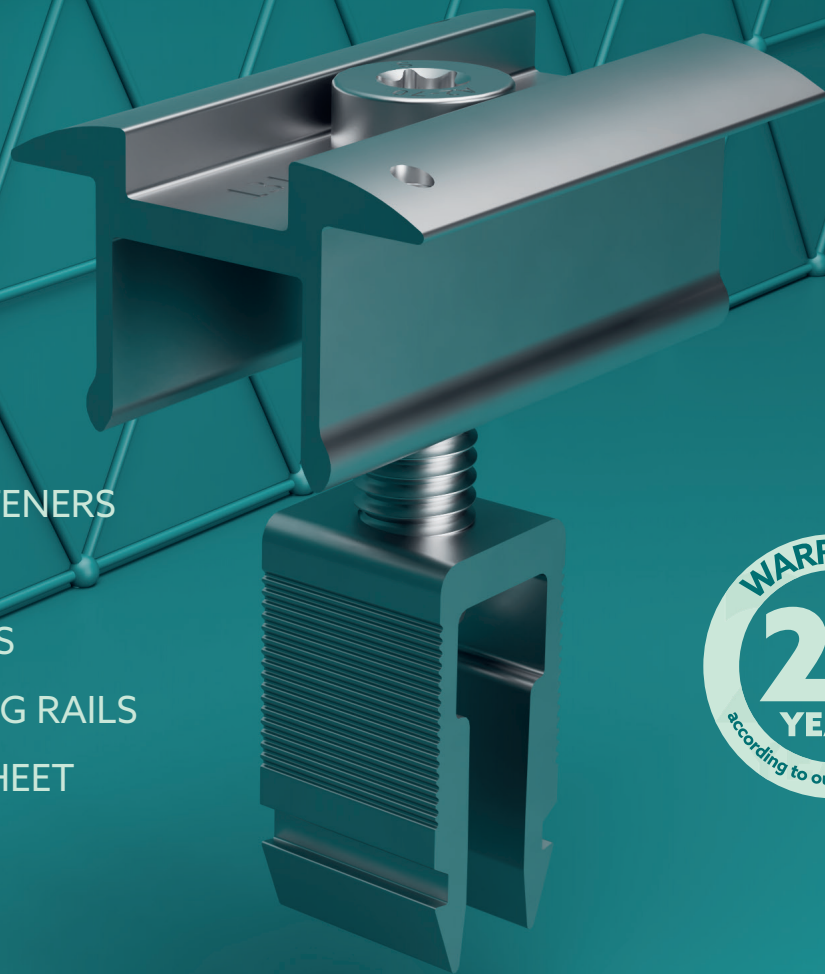

FIXGRID PRO

FIXGRID PRO LETS YOU ADJUST THE DESIRED ANGLE OF INCLINATION FLEXIBLY. CREATE AN INFINITE NUMBER OF VARIATIONS WITH JUST A FEW COMPONENTS.

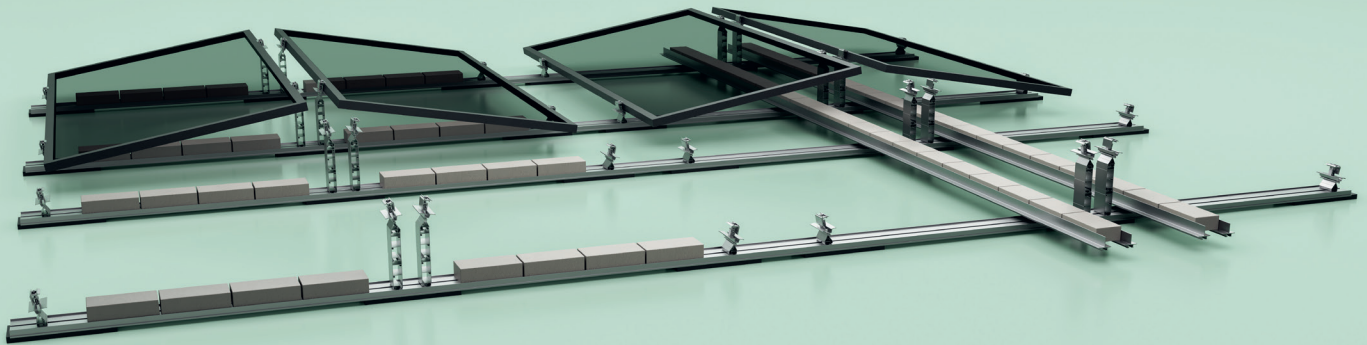

- + Ballast optimization and reduction through improved aerodynamics
- + Flexible and time-saving planning and assembly
- + Compatible with module clamps from the ProLine series
- + Tool-free assembly of the heightening elements
- + Modules can be mounted portrait or landscape and clamped either on the short or long side
- + Possible module inclination of 5/10/15 degrees, independent of module clamping, orientation, and size

BALLAST AND COMPOSITE RAIL



BALLAST RAIL CONNECTORS



FLOOR PROFILE CONNECTORS



FLOOR PROFILE

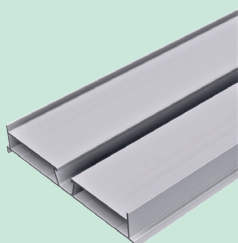

MODULE SUPPORT



HEIGHTENING ELEMENT



UNIVERSAL FASTENERS

- + Improved adjustability and stability
- + Higher load capacity due to new profile geometries

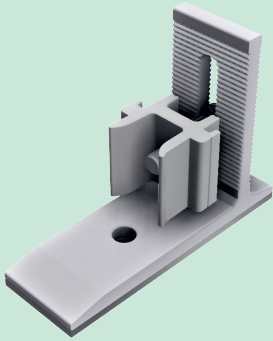

RAPID 2+ SML PRO

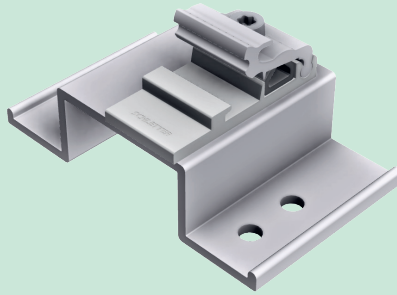

FIX T-K PRO

MODULE BEARING RAILS

- + Aluminum EN AW-6063 T66
- + Reduced material with improved stability
- + Module bearing rails available in various lengths

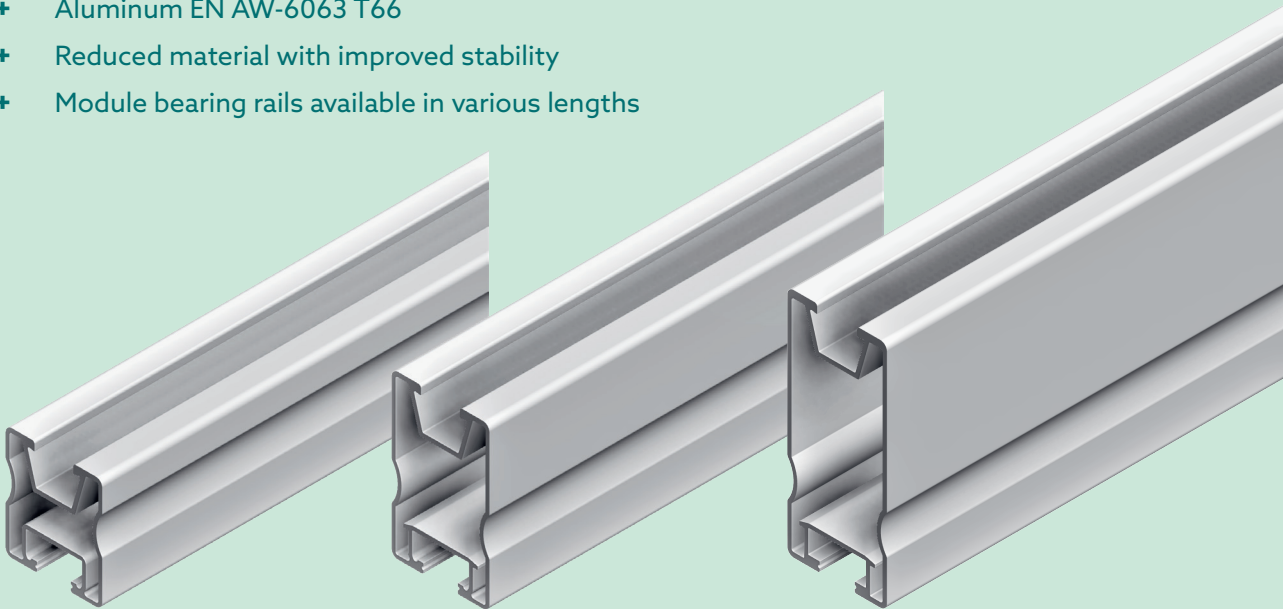

PROFILE PRO 35

PROFILE PRO 50

PROFILE PRO 70

SEAM CLAMPS

- + Can be combined with all Classic profiles from Schletter
- + Quick assembly
- + Variable use
- + Excellent value

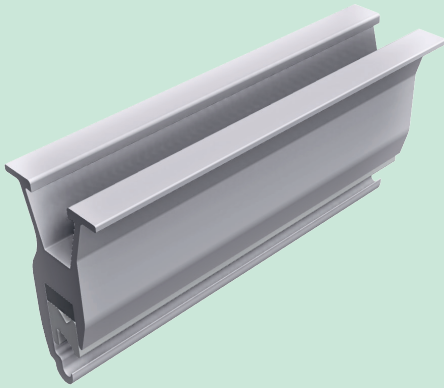

SEAM CLAMP PRO 504



SEAM CLAMP PRO 524

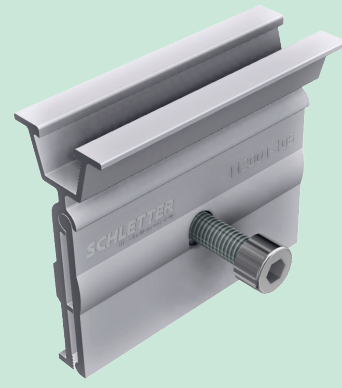

SEAM CLAMP PRO 503

TRAPEZOIDAL SHEET CONNECTIONS

- + Compatible with all Schletter Classic profiles
- + Screws onto the side of the trapezoidal sheets for optimum load distribution
- + Innovative system to connect to the substructure



CLAMPFIT PRO

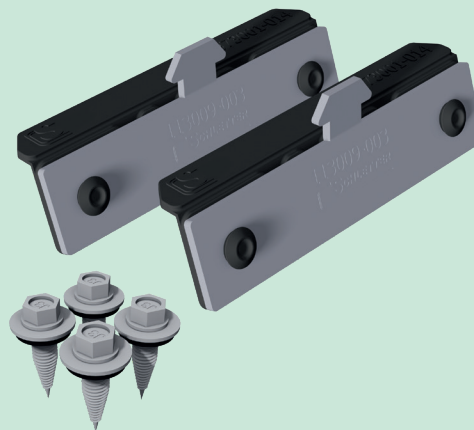

SINGLEFIX PRO

MODULE CLAMPS

- + Middle and end clamps for mounting module frames between 1.18" -1.85"
- + Mounting with Torx T40
- + Completely pre-assembled for quick installation
- + Built-in grounding function
- + Available in bright and black anodized aluminum
- + Optimized packaging units

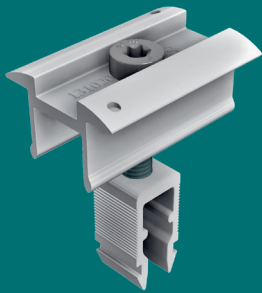

MIDDLE CLAMP PRO

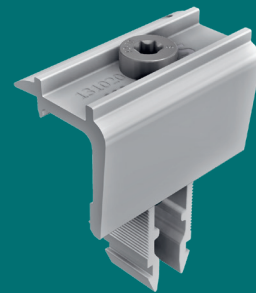
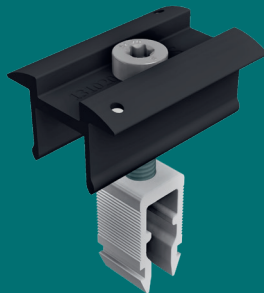

END CLAMP PRO

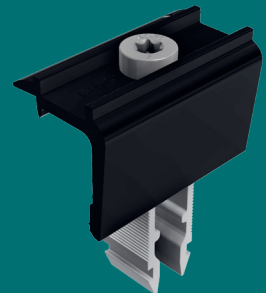

ACCESSORIES

- + ProConnector - tool-free, self-locking slide-in connector
- + Cross-connector 90 Pro with Torx T40 can be installed with ProLine rails to all Schletter Classic rails
- + KlickTop Pro Hanger Bolt Adapter - Hanger bolt mounting adapter for Classic and ProLine module support profiles
- + Rapid Connector 90 Pro can be installed on top with either ProLine rails or Schletter Classic rails to all rails of the ProLine series
- + Plastic end cap for ProLine module support profiles

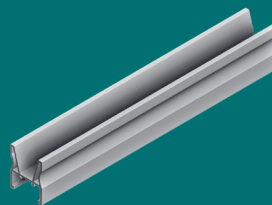

PRO INTERNAL CONNECTOR

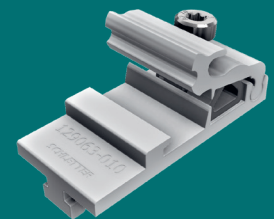

CROSS CONNECTOR 90 PRO



KLICKTOP PRO



RAPID CONNECTOR 90 PRO

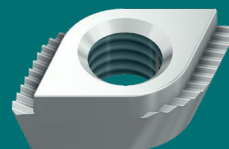

HAMMERHEAD NUT PRO



PRO PLASTIC END CAP

SCHLETTER

WE SUPPORT SOLAR.

AT SCHLETTER, WE BELIEVE THAT ANY ENTERPRISE, BIG OR SMALL, CAN ONLY BENEFIT FROM PASSIONATE SUPPORT.

And if ever there were an industry worth supporting, it's solar. Which is why we care about the success of every solar company, including yours.

We're here to urge you forward and support your initiative with products engineered to ensure the success of your projects - which will change our lives, and the planet, for the better.

If you don't deserve our support, who does?

WHOLESALER:

PowerStore, Inc., Texas Office

4305 Longhorn Drive, Alvarado, TX 76009

1-866-752-4439

sales@powerstore.com

www.powerstore.com

PowerStore, Inc., North Carolina Office

236 Raceway Drive, Mooresville, NC 28117

1-704-274-2998

NCSales@powerstore.com

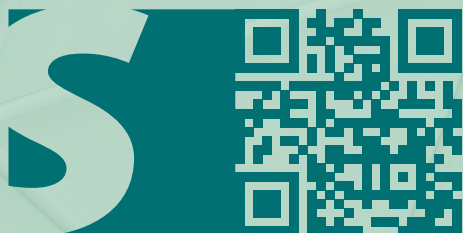

SCHLETTER NA INC.

11529 WILMAR BOULEVARD, CHARLOTTE, NC 28273, USA

EMAIL: infoNA@SCHLETTER-GROUP.COM

WWW.SCHLETTER-GROUP.COM

SCAN ME.

